

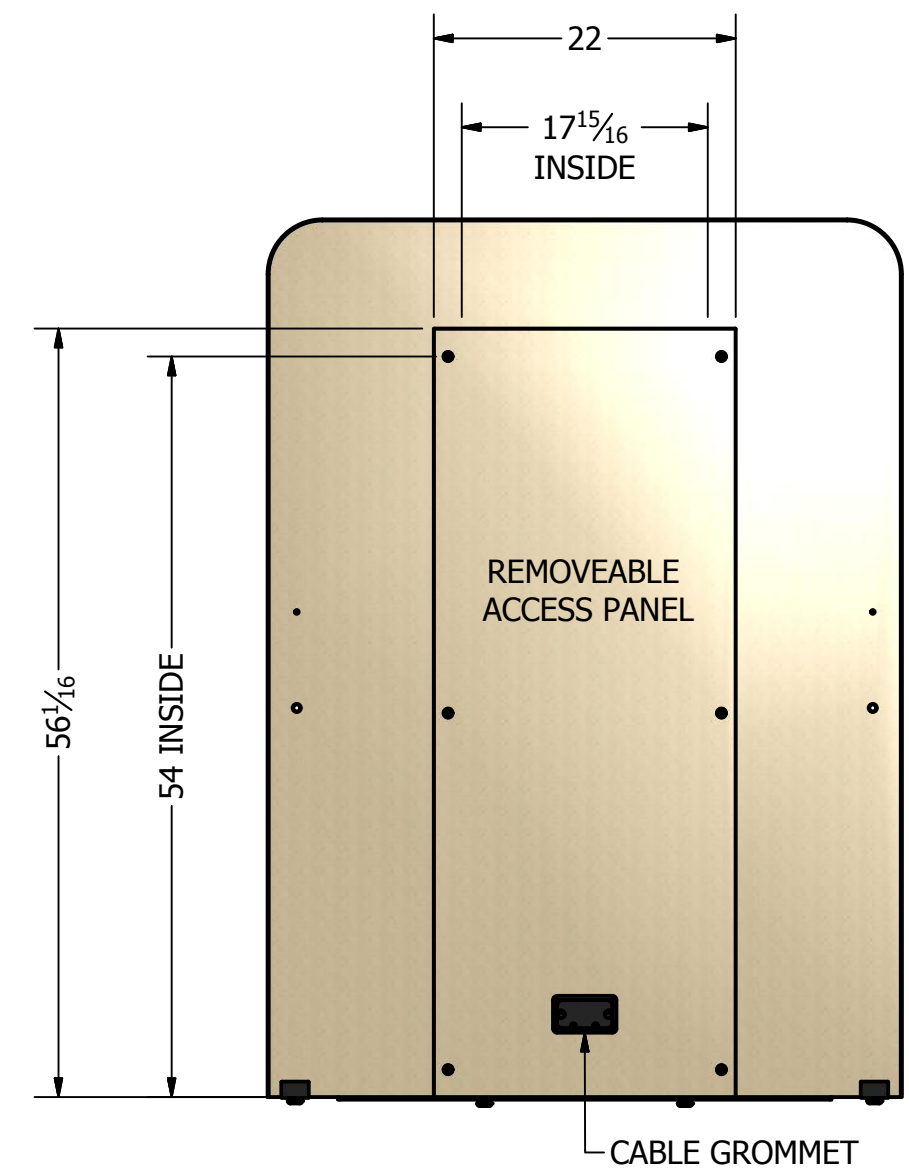

ATF-CT-RD28

TABLE WITH REAR DISPLAY MOUNT, 28" CHAIR HEIGHT

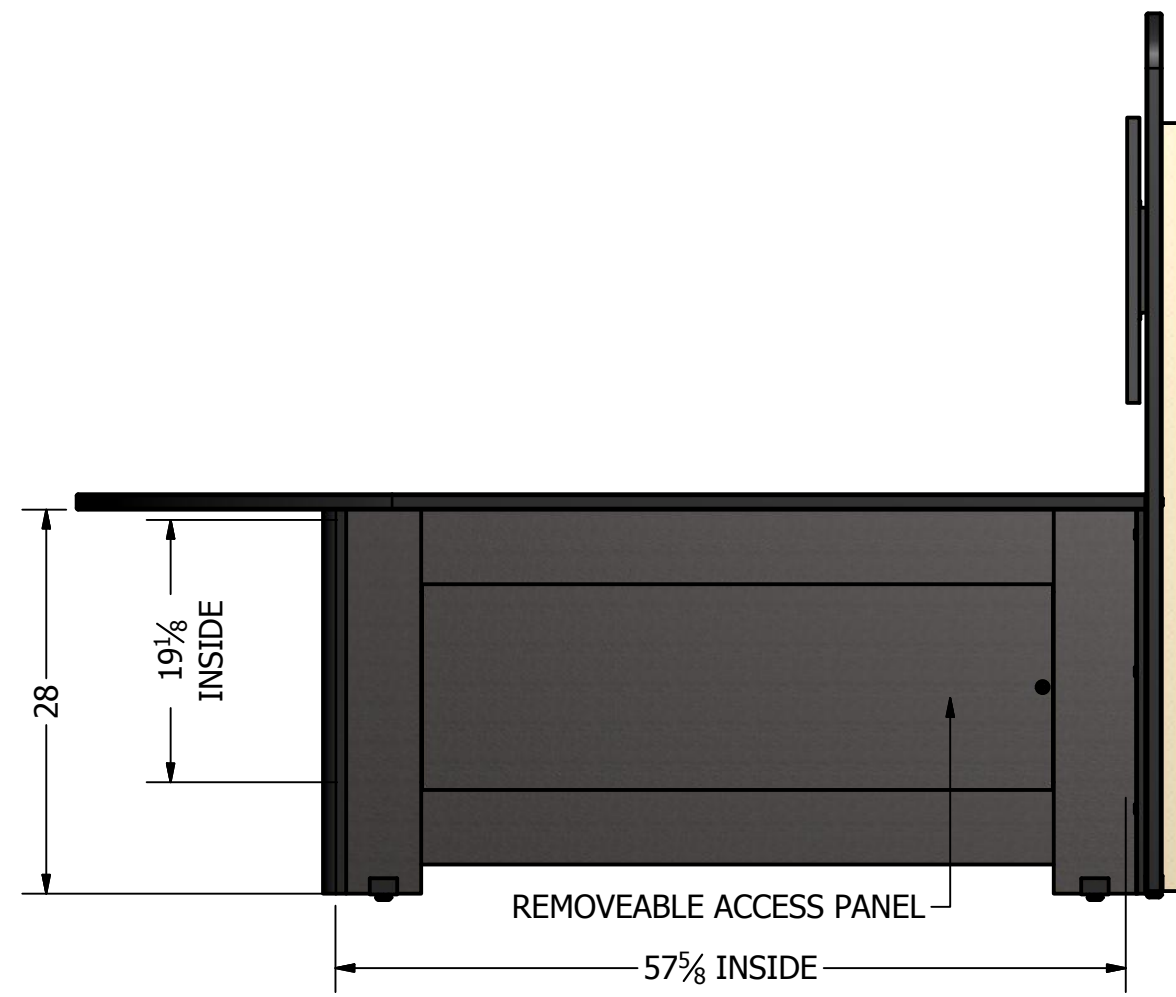
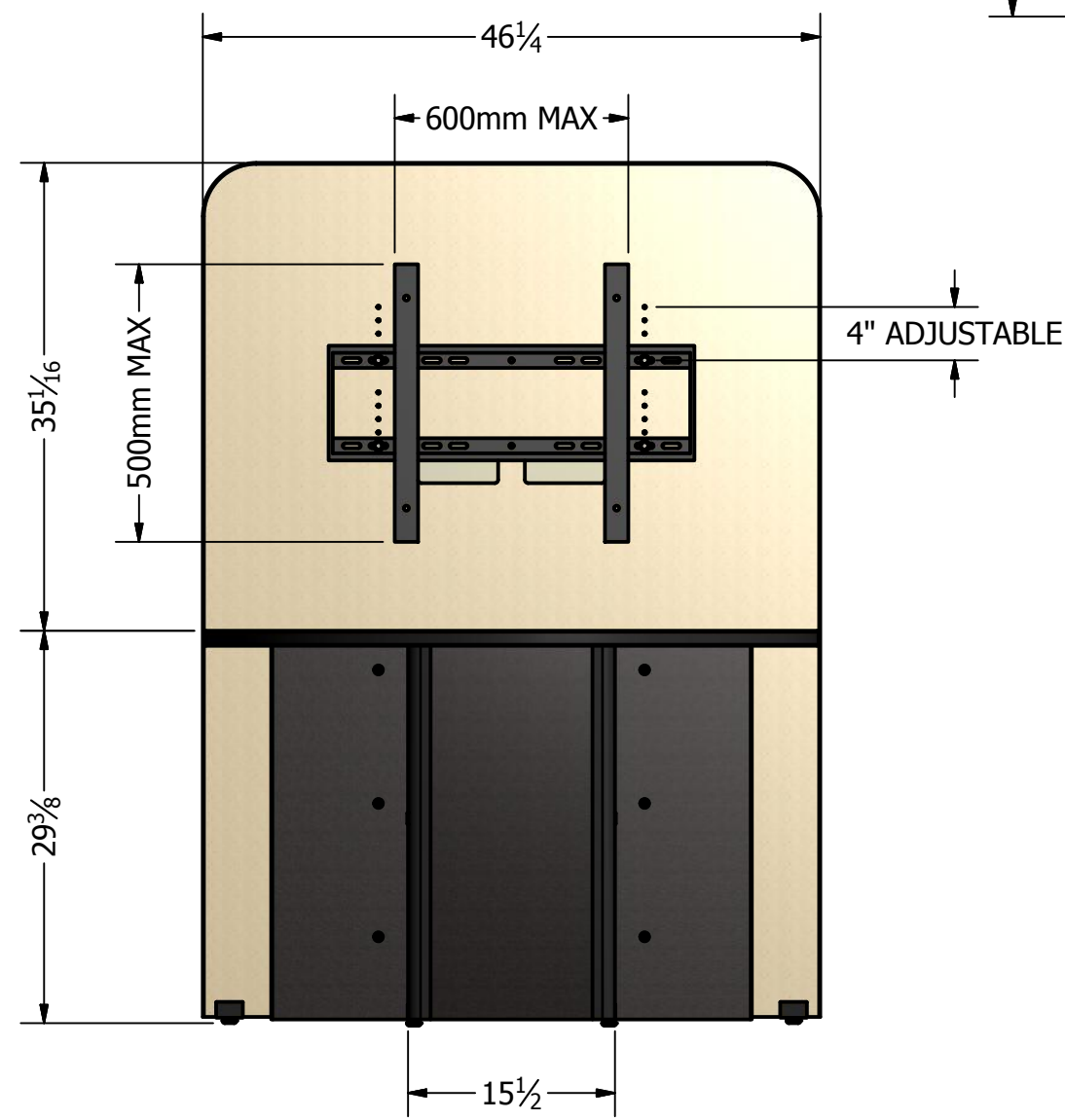
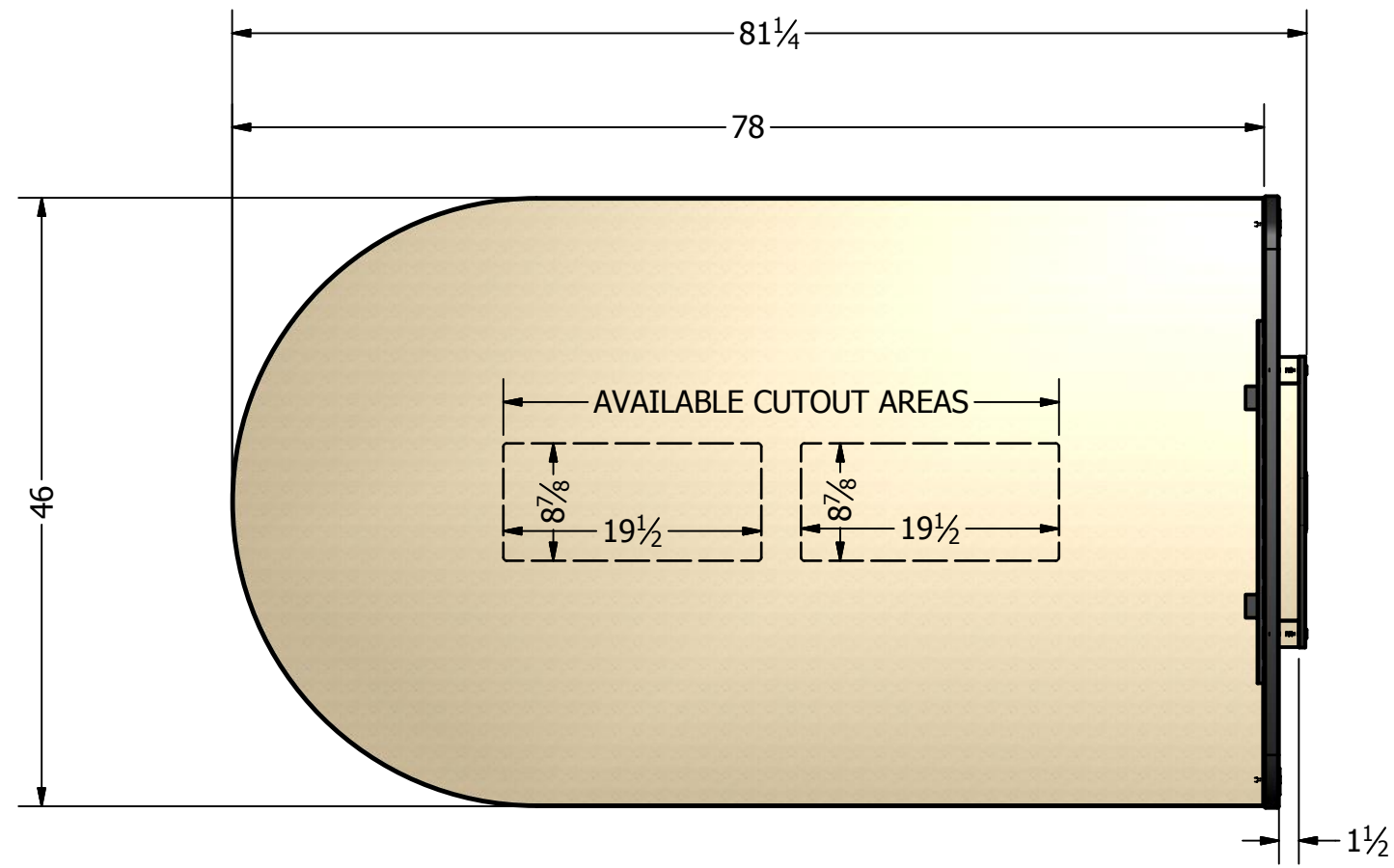

DRAWN curleyk	1/29/2015	COPYRIGHT 2015, AMERICAN TECHNICAL FURNITURE		
CHECKED		TITLE		
QA		CT SERIES		
MFG	1/29/2015			
APPROVED				
		SIZE C	DWG NO SHARE SPACE CT SERIES_012915	REV
		SCALE	SHEET 1 OF 4	

ATF-CT-RD35

TABLE WITH REAR DISPLAY MOUNT, 35" STOOL HEIGHT

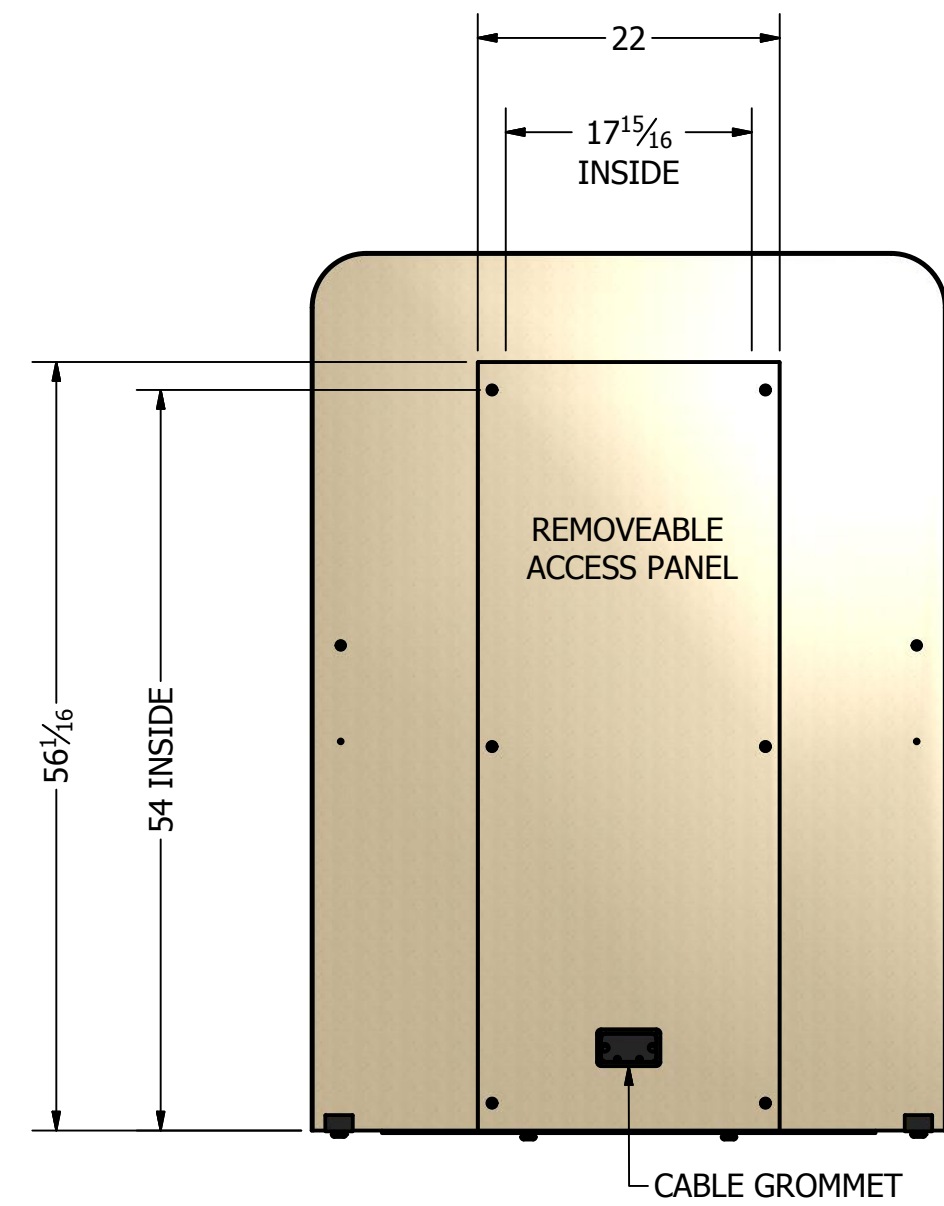
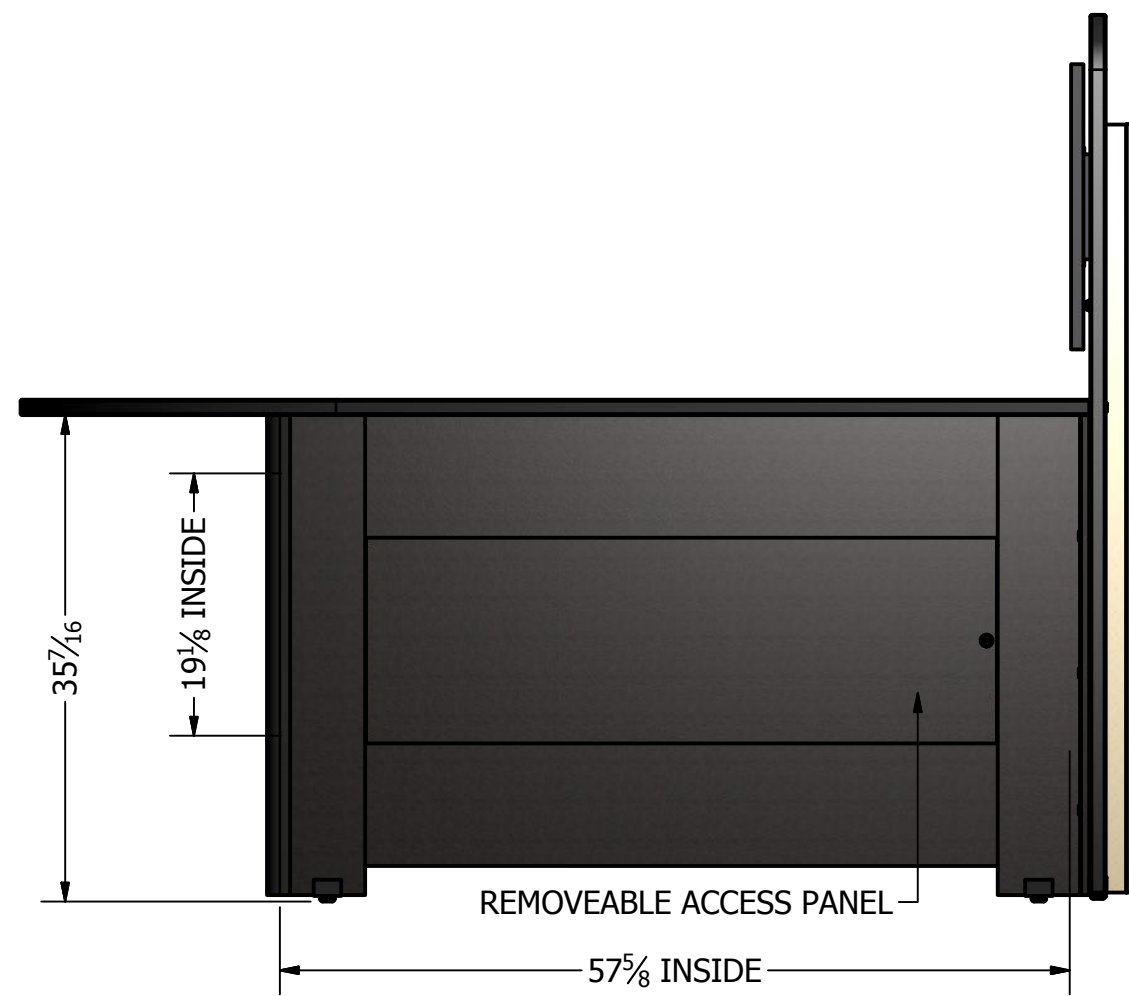
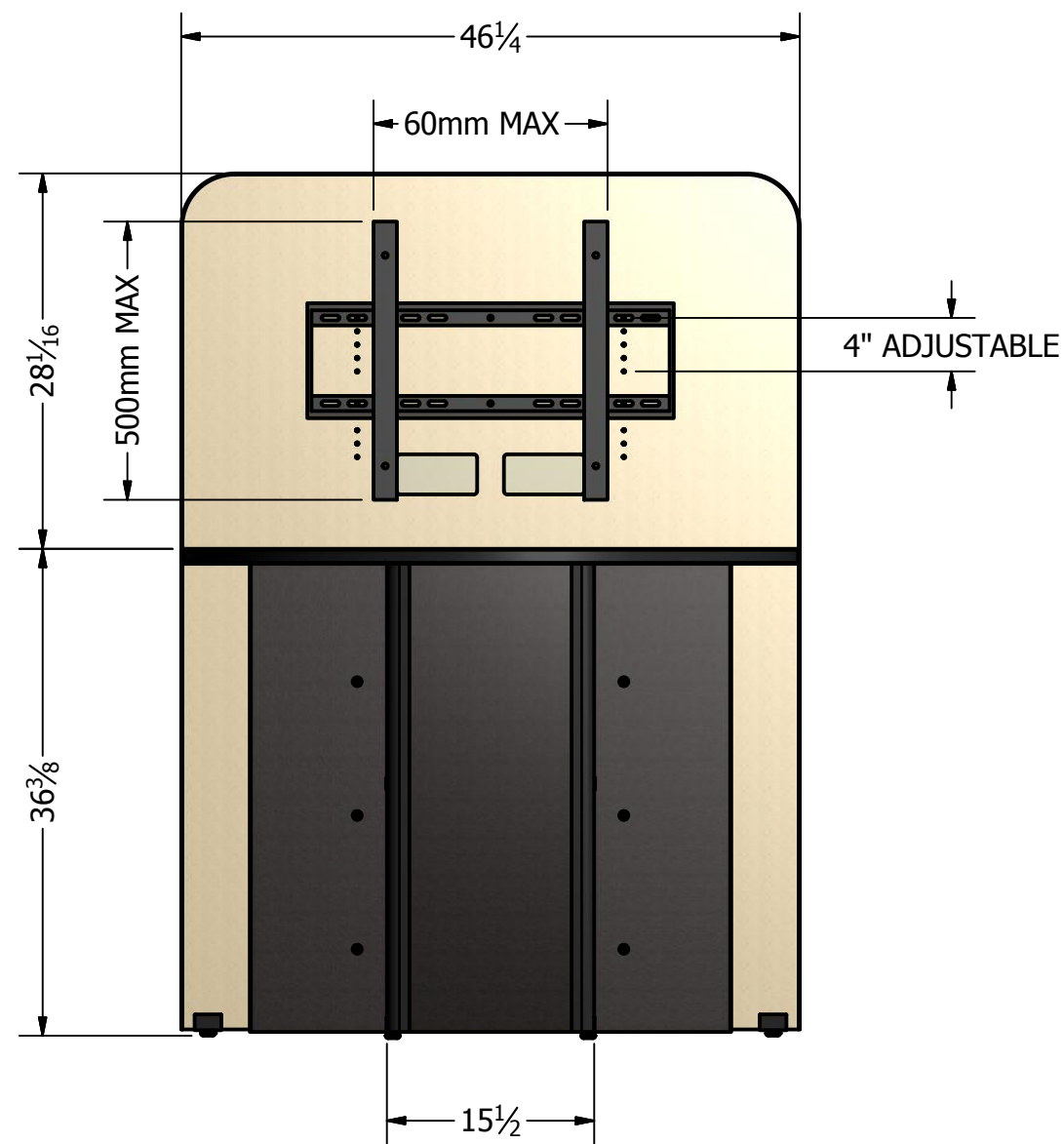
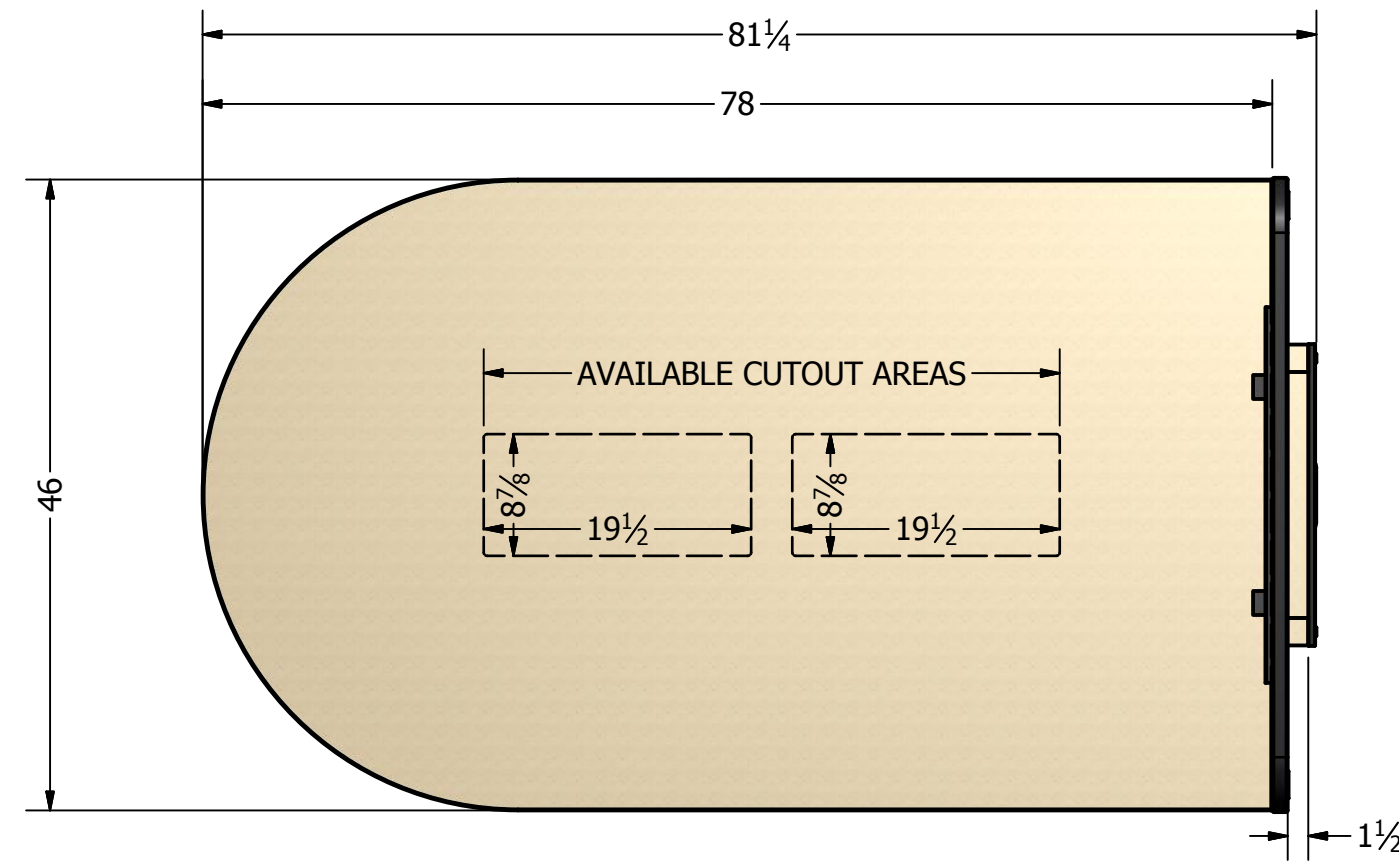

DRAWN curleyk	1/29/2015	COPYRIGHT 2015, AMERICAN TECHNICAL FURNITURE	
CHECKED		TITLE	
QA		CT SERIES	
MFG	1/29/2015	 AMERICAN TECHNICAL FURNITURE	
APPROVED			
		SIZE C	DWG NO SHARE SPACE CT SERIES_012915
		SCALE	REV SHEET 2 OF 4

ATF-CT-BT28

BASE TABLE, 28" CHAIR HEIGHT

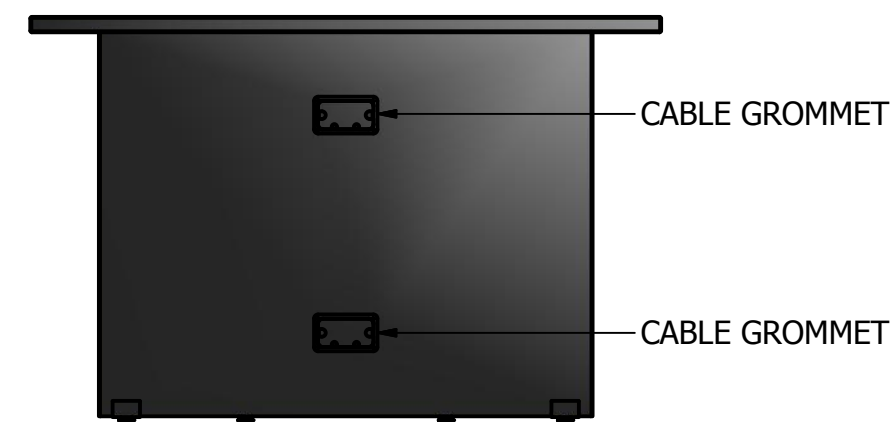
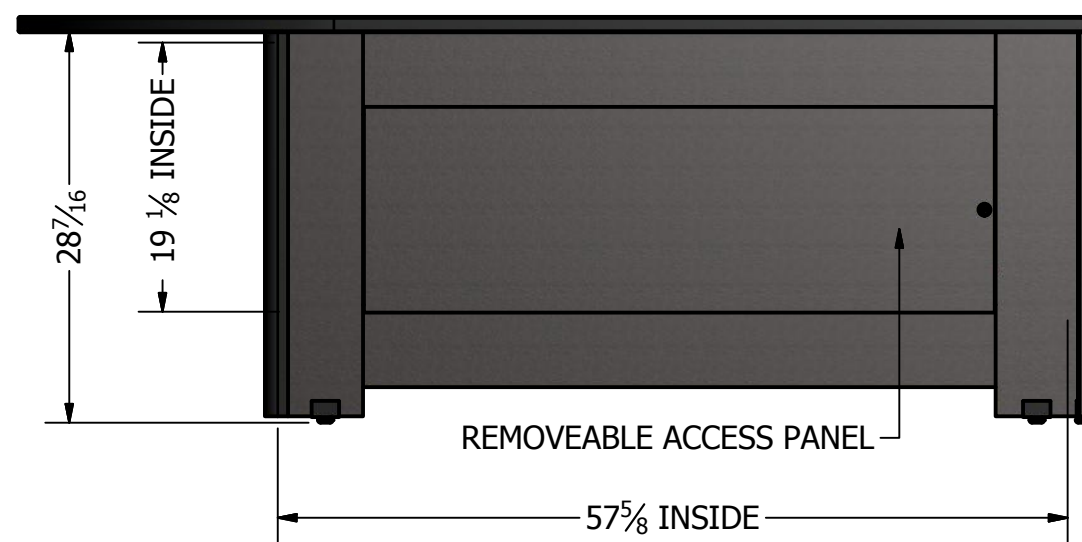
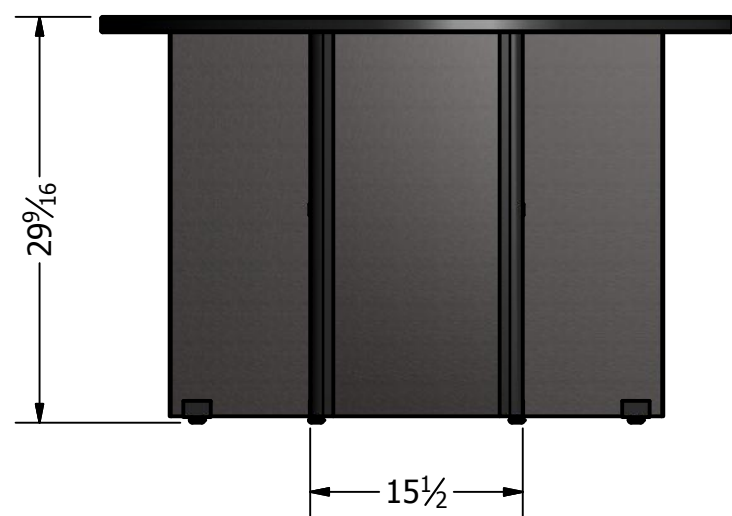
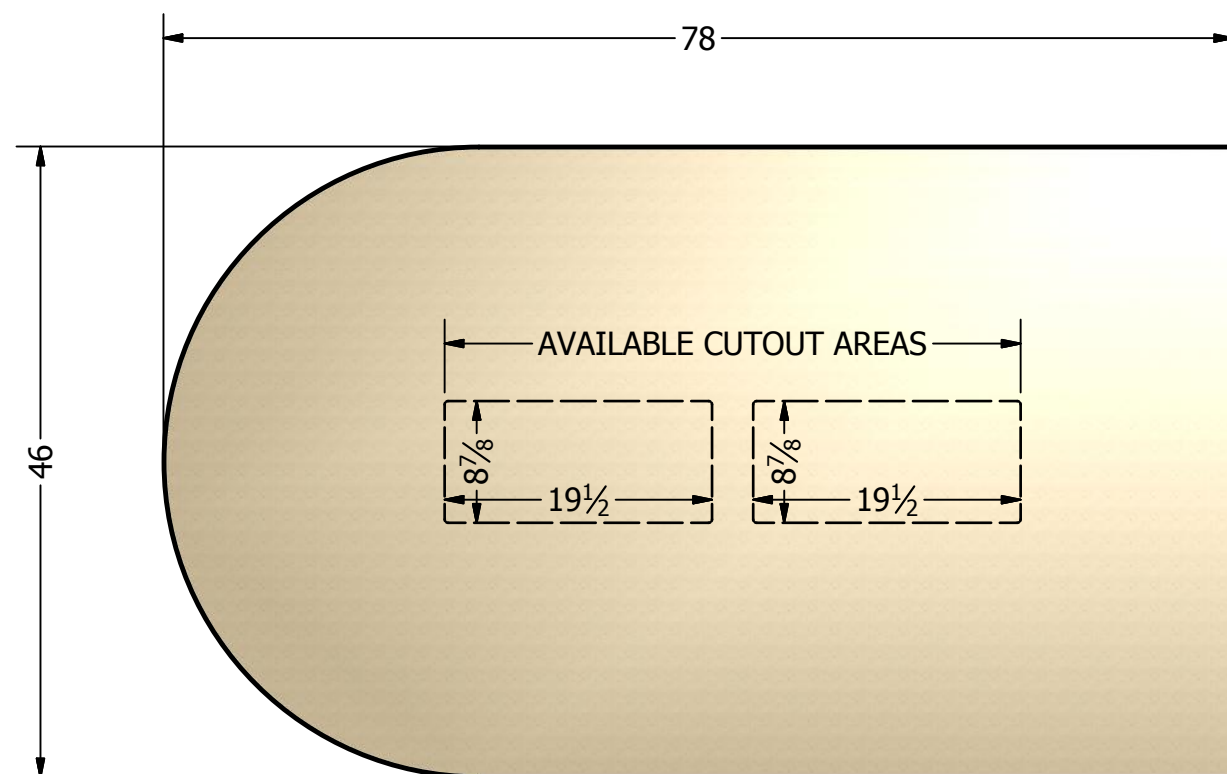

DRAWN curleyk	1/29/2015	COPYRIGHT 2015, AMERICAN TECHNICAL FURNITURE		
CHECKED		TITLE		
QA		CT SERIES		
MFG	1/29/2015			
APPROVED				
		SIZE C	DWG NO SHARE SPACE CT SERIES_012915	REV
		SCALE	SHEET 3 OF 4	

ATF-CT-BT35

BASE TABLE, 35" STOOL HEIGHT

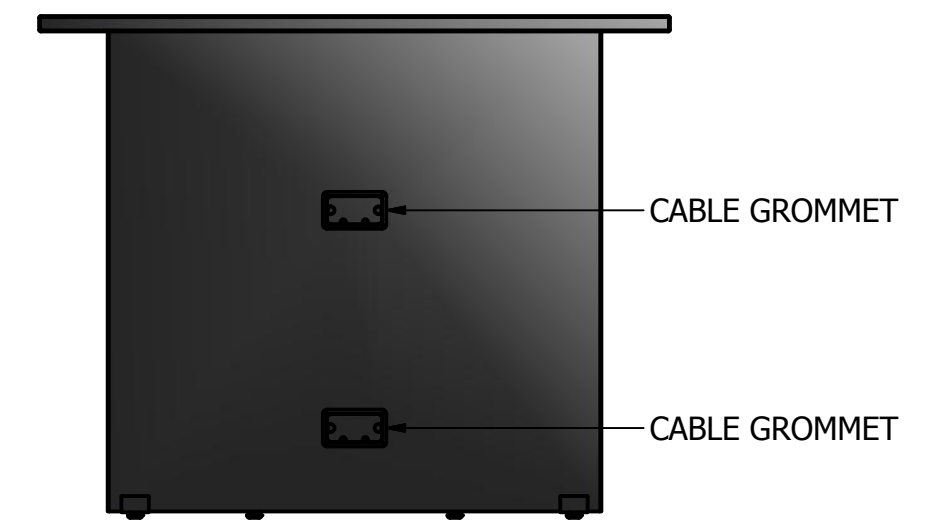
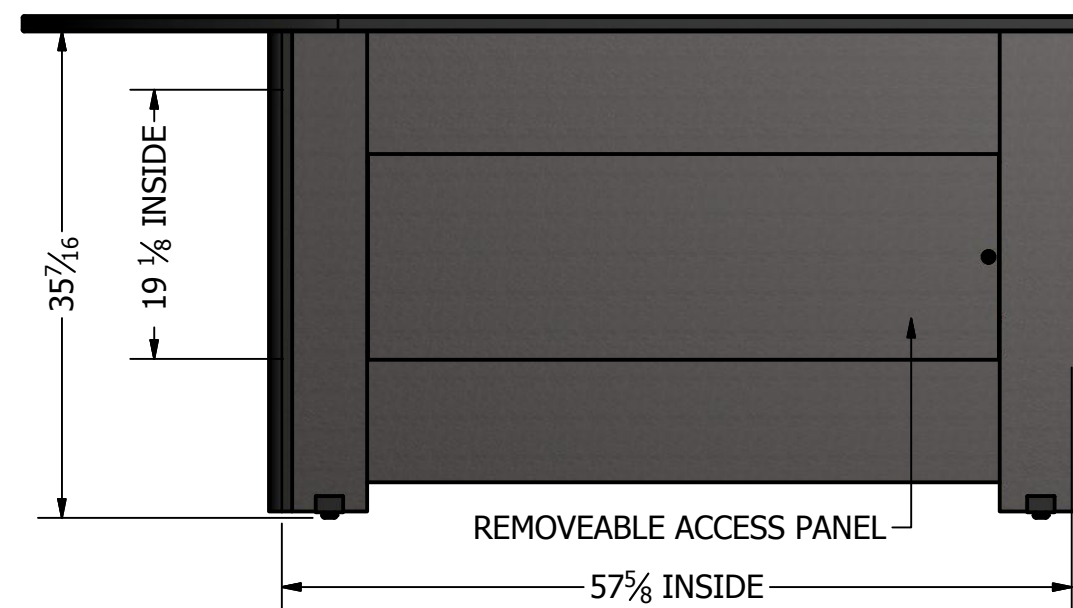
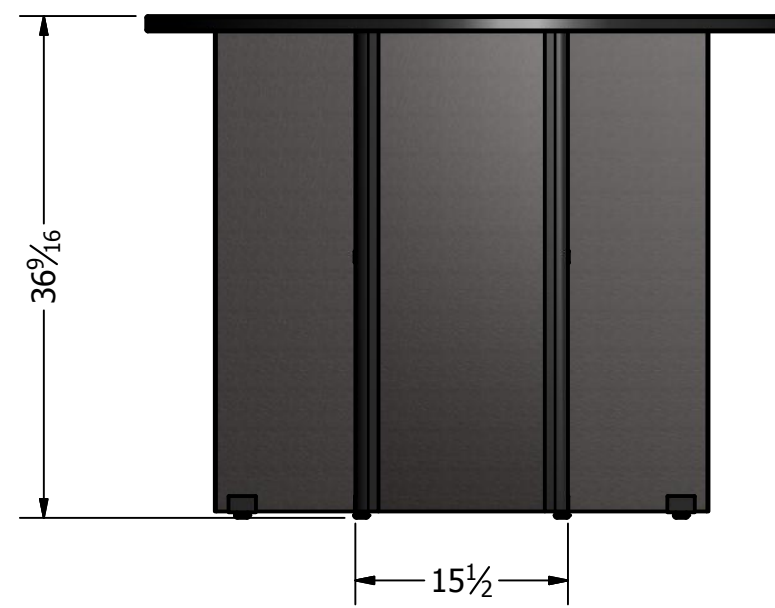
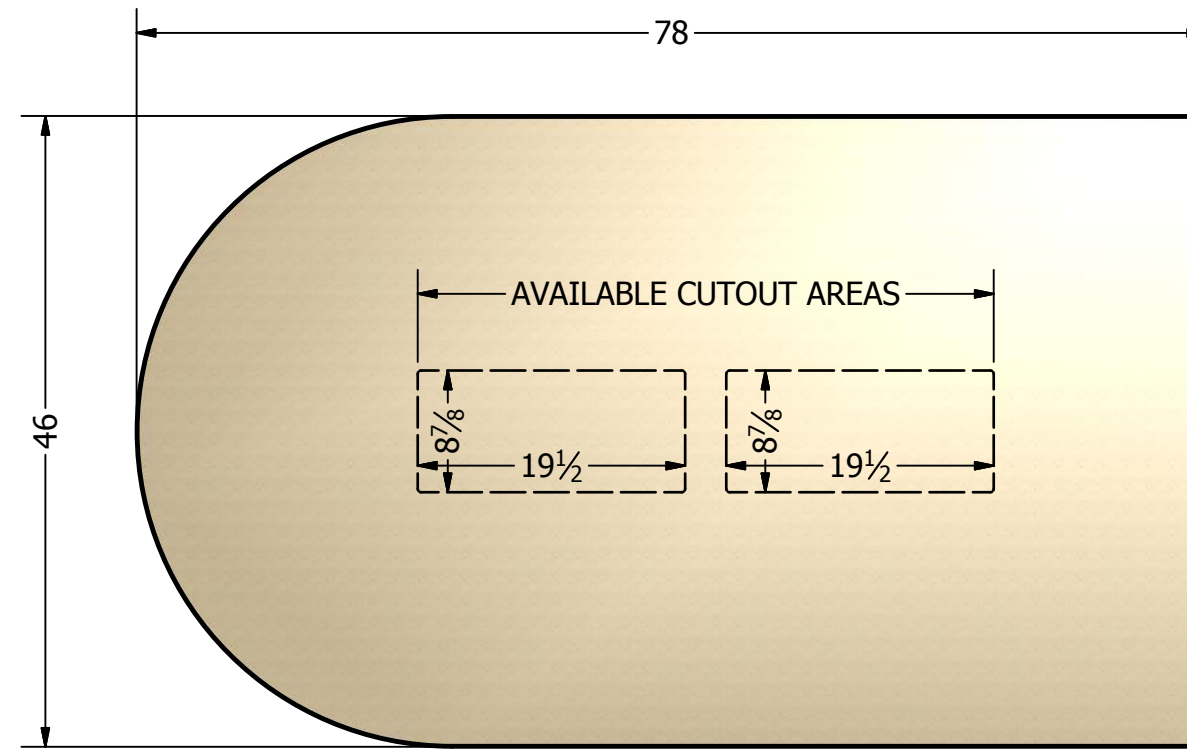

DRAWN curleyk	1/29/2015	COPYRIGHT 2015, AMERICAN TECHNICAL FURNITURE		
CHECKED		TITLE		
QA		CT SERIES		
MFG	1/29/2015	 AMERICAN TECHNICAL FURNITURE		
APPROVED				
		SIZE C	DWG NO SHARE SPACE CT SERIES_012915	REV
		SCALE	SHEET 4 OF 4	